

This Legal Acknowledgement Form shall be governed by the laws of the Province of British Columbia and the applicable federal laws of Canada. In the event of conflicts or inconsistencies, if any, between or among this Legal Acknowledgement Form and the terms and conditions of the Standard, the provisions set out in this Legal Acknowledgement Form take precedence.

Disclaimer

The Standard, and all information and referenced standards therein, is provided as a public service by the British Columbia Hydro and Power Authority ("BC Hydro"). Material contained within it carries no guarantee of any kind, express or implied.

Neither BC Hydro nor the Standard designer, recommender, or acceptor, are accountable for the manner in which the Standard is used, or in the way its content is applied. Persons using the Standard, including retained engineers and contractors, are responsible and assume full responsibility and liability for its application, including but not limited to ensuring that the application of its content is appropriate, and that its application does not compromise operability, safety, reliability or maintainability.

The Standards have been prepared for or by BC Hydro to meet specific purposes of BC Hydro. No person shall use or rely upon the Standard, in whole or in part, in any manner, except:

- a) for the purpose of providing services to BC Hydro;
- b) for the purpose of connecting equipment to BC Hydro equipment;
- c) with the prior written consent of BC Hydro, or
- d) as required by law.

Limitation of Liability

BC Hydro, its servants or agents, shall not be liable to any person for injury, loss or damage arising out of the use of or reliance upon this Standard, in whole or in part, except for those situations where the person uses the Standards to provide services to BC Hydro to the extent damages are not due to the fault of the person using the Standard, including but not limited to that person's misapplication of the Standard, negligence, or misconduct.



Any person using these Standards hereby agrees to release and indemnify BC Hydro, its servants or agents, from any injury, loss, damage or claim arising or alleged to be arising from use of or reliance upon the Standards, in whole or in part, except for those situations where the person directly uses the Standards to provide services to BC Hydro to the extent damages are not due to the fault of the person using the Standard, including but not limited to that person's misapplication of the Standard, negligence, or misconduct.

Copyright

BC Hydro holds all title and rights, including the copyright, in or to the Standard. Copying all or any part of this Standard is permitted provided copies are used in accordance with this Legal Acknowledgement Form, credit is given to BC Hydro, and copies of the Standard or parts thereof are not sold for profit. The Standard may be stored in any type of electronic retrieval system provided BC Hydro is clearly indicated as the source and provided no profit accrues from such storage.

BC Hydro notes that the Standard may be revised from time to time and recommends that any person using the Standard in accordance with this Legal Acknowledgement Form confirm it is using the most recent version. BC Hydro is not liable for reliance on past versions of the Standard that may be stored electronically.

REVISIONS: UPDATED LEGAL ACKNOWLEDGEMENT FORM. FD MAR '16

| | | | | | |
|--|-------------|--|---|---|----------------------------------|
| DESIGNED | RECOMMENDED | ACCEPTED | ENGINEER OF RECORD | <p>NOTICE FROM THE EXECUTIVE VICE PRESIDENT TRANSMISSION AND DISTRIBUTION AND CUSTOMER SERVICE</p> | |
| J. AGNOLIN | F. DENNERT | G. REIMER |  | | |
| <p>DISTRIBUTION STANDARDS</p>  | | <p>ISSUED: MAR 2016 REPLACES: MAY 2004 ORIGINALLY ISSUED: NOV 1980</p> | | <p>PAGE 1 OF 2</p> | <p>ES43/53/54/55/65 A1-01.01</p> |
| | | | | R | 4 |

Scope

This manual is one of a series containing standards for construction of the BC Hydro electrical distribution plant within the service area of BC Hydro. A new distribution plant shall be designed, constructed, owned, operated, maintained and repaired to these standards.

Purpose of Standards

BC Hydro objectives require standardization to:

- a) Ensure uniform safety requirements comply with BC statutes and regulations.
- b) Provide uniform system reliability.
- c) Provide uniform operating practices.
- d) Permit economic bulk purchasing of materials.
- e) Achieve optimum life cycle cost of plant construction.
- f) Effect efficient quality assurance.

Responsibility

The Distribution Standards Department prepares these standards and verifies that specified plant and procedures will perform adequately under all normally expected conditions encountered throughout the province of British Columbia. These standards are approved by Professional Engineers. It is the responsibility of BC Hydro Managers to ensure that the standards are followed unless abnormal conditions are encountered that require variations. These variations should be kept to a minimum and their performance shall be the responsibility of the Professional of Record in charge of the project, who will record and seal the variation based on satisfactory qualifications and experience to do so. As per the latest revision of the BC Hydro Distribution Owner's Engineer Guide, these variations must be accepted by BC Hydro's Owner's Engineer.

Use of Stock Materials

The electrical distribution plant covered by these standards is built using stock materials approved by a Professional Engineer as required by law. The use of non-stock materials for special and unusual situations must be approved by Distribution Standards or the BC Hydro Engineer responsible for the project.

Revisions to Manual





These standards are revised from time to time to improve the safety, performance, workability, cost effectiveness or appearance of the plant. The existing plant built to previous standards need not be updated unless so specifically advised by BC Hydro. When maintenance or other work, such as voltage conversion or conductor change is being done, updating plant to current standards is encouraged.

Mailing Addresses

The manual has been issued to a corporation or firm rather than to an individual. The corporation or firm is responsible for the safekeeping of the manual, and for keeping it current. Changes of address or in number of copies required must be reported promptly.

Suggestions for changes in the manual, or required changes of address may be made on the pre-addressed comment sheet included in the Manual and with each issue of revision.

REVISIONS: UPDATED LEGAL ACKNOWLEDGEMENT FORM. FD MAR '16

| | | | | | | |
|--|--|--|--|--|---------------------------|--------|
| DESIGNED J. AGNOLIN | RECOMMENDED  F. DENNERT | ACCEPTED  S. REIMER | ENGINEER OF RECORD  F. U. DENNERT BRITISH COLUMBIA ENGINEER | NOTICE FROM THE EXECUTIVE VICE PRESIDENT TRANSMISSION AND DISTRIBUTION AND CUSTOMER SERVICE | | |
| DISTRIBUTION STANDARDS  | | ISSUED: MAR 2016 REPLACES: MAY 2004 ORIGINALLY ISSUED: NOV 1980 | | PAGE 2 OF 2 | ES43/53/54/55/65 A1-01.02 | R 4 |

Scope

This section briefly summarizes the pertinent administrative and technical details for building pole structures which comply with joint use standards and B.C. regulatory requirements.

Joint Use Agreement between BC Hydro and TELUS

By an "Agreement" made in 1971 and amended and restated in 2015, all distribution poles used by both BC Hydro and TELUS shall be owned 60% by Hydro and 40% by TELUS with the exception of distribution poles used as clearance contact poles. The Agreement details the terms under which joint ownership operates. Both parties have Joint Use Administration Departments for the purpose of administering the day to day procedures and a Joint Use Coordinating Committee (JUCC) exists to review and interpret the Agreement, and approve administrative procedures. In addition, a Joint Use Technical Committee (JUTC) meets as required to address technical issues and develop joint use construction and maintenance standards.

The Agreement makes provision for each party to sublet part of its allotted pole space to a third party for a wire contact. Such contacts are covered by separate agreements made for each third party.

Line Design for Joint Use with TELUS

The Agreement with TELUS requires that the party constructing a jointly owned line has an obligation to build the line to be suitable for joint use and in conformance with the standards of both parties. The party making subsequent contact to the poles has an obligation to ensure that those standards are being followed, and that no damage or hazard is brought about by their work to the other party.





At the design stage for joint use pole lines, a local dialogue between BC Hydro and TELUS is essential to establish a mutually satisfactory design. The designer must obtain clear information on TELUS's planned requirements for clearances, span lengths, pole quadrant usage, equipment space, and the mechanical forces that pole structures must withstand to support communications plant. This information will affect the length and class of pole, the staking, and the guying and anchoring design.

Due to heavy anchoring requirements of TELUS, two separate anchors are usually needed at joint dead-end poles and sometimes at angle poles for power and telecommunications plant. Where this is the case, the party building the line is obliged to install both anchors. This procedure avoids the difficulty of installing a telecommunication anchor after the primary anchor has been installed and guyed. It also ensures that both parties agree on the anchoring requirements.

At the time of a joint pole replacement BC Hydro, TELUS and Third Party anchoring shall be replaced in accordance with Joint Use Bulletin #016.

- Various details on required joint use practices not included in this Section are to be found elsewhere in these ES43 and ES55 Standards:
- for clearances and vertical spacing on joint poles, see ES43 Section B, and ES55 Sections B and E.

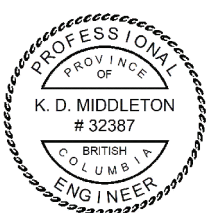
REVISIONS: R5. UPDATED CONTENT AND ADDED ES65 AND ES43 REFERENCES. APR. 20' KM

| | | | | | |
|--|---|---|---|--|----------------------|
| DESIGNED  K. MIDDLETON | RECOMMENDED  H. GIESBRECHT | ACCEPTED  F. DENNERT | ENGINEER OF RECORD  | <h3>JOINT AND SECONDARY USE GENERAL NOTES</h3> | |
| DISTRIBUTION STANDARDS  | | ISSUED: APR 2020 REPLACES: NOV 2012 ORIGINALLY ISSUED: JUN 1986 | | PAGE 1 OF 4 | ES43 C1-01.01 |
| | | | | R | 5 |

REVISIONS: R5. REMOVED MID-SPAN SAGS TABLE; ADDED REQUIREMENT FOR VERTICAL SPACING TO BE DOCUMENTED ON THE POLE PLAN. APR. 20' KM

- for wind loading and pole selection, see ES55 Section E.
- for guying and anchoring, see ES43 Sections E and ES55 Section E.
- for climbing space and equipment boxes on poles, see Section G.
- for grounding, see ES43 Section R and ES55 Section H.
- for duct and pilaster locations on the pole, see ES43 Section M.

BC Hydro/TELUS Redress Procedures

Since most joint poles are constructed by either BC Hydro forces or BC Hydro contractors, it is essential that all of the agreed upon design details are made known to the respective line crews and incorporated in the completed power line. If it is found that the subsequent addition of telecommunications plant to a pole has caused damage, or has created a hazardous situation and it can be documented that the line was built to accommodate TELUS's design requirements and standard installation practices, then BC Hydro may seek redress from TELUS. If satisfactory arrangements cannot be made at a local level, then the Joint Use Coordinating Committee (JUCC) should be supplied with all the facts, and asked to intercede.





Vertical Separation at the Pole between BC Hydro Neutral and Highest TELUS Messenger

Minimum safety separations at the pole are given on ES43 C2-01. Minimum in-span separations are given on ES43 C2-02.

Due to the sag incompatibility between BC Hydro wires and messenger supported communications wires, special consideration must be given to providing additional vertical separation at the pole to match wire sizes and span lengths to meet minimum CSA mid-span separations as detailed in ES43 C2-02. See ES43 C2-03 and C2-04 for typical separations at the pole for the corresponding span lengths. TELUS practice is to always mount the fibre-optic cable in the highest TELUS communications position. The wire sizes and span lengths will dictate the required additional separation at the pole.

Documentation on the Pole Plan of the required vertical separation between the BC Hydro neutral and the highest TELUS messenger is required to communicate this critical dimension to TELUS construction resources.

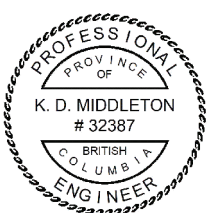
At the design stage, local dialogue between BC Hydro and TELUS is essential to establish a mutually satisfactory wire separation at the pole. Subsequently, each party must convey to their respective construction crews adequate wire placement information to prevent construction errors. For joint use pole lines built by BC Hydro, exactly where to place the neutral on each pole must be conveyed to the line crew. The neutral then becomes the reference point by which TELUS places its highest messenger.

| | | | | | |
|--|---|---|---|--|----------------------|
| DESIGNED  K. MIDDLETON | RECOMMENDED  H. GIESBRECHT | ACCEPTED  F. DENNERT | ENGINEER OF RECORD  | JOINT AND SECONDARY USE GENERAL NOTES | |
| DISTRIBUTION STANDARDS  | | ISSUED: APR 2020 REPLACES: NOV 2012 ORIGINALLY ISSUED: JUN 1986 | | PAGE 2 OF 4 | ES43 C1-01.02 |
| | | | | R | 5 |

During construction, it is important that both parties, BC Hydro and TELUS:

- a. Accurately place conductors and messengers on the pole as per the design; and
- b. Accurately sag conductors and messengers as per their respective standard stringing sag tables.

Accommodation of BC Hydro Third Party Communication Licensee on Joint Use Poles

a. A "joint use pole" is defined as a distribution pole that is jointly owned by BC Hydro and TELUS.

b. General:

A third party contact agreement and a Specific Permit of Occupation (SPO) is required before BC Hydro licensee equipment is attached to a BC Hydro or joint use distribution pole (Refer to Distribution Instructions D12-3 and D12-5).

Third Party licensees shall typically be supported by a minimum Size 6 messenger.

The addition of communication messengers, cables and equipment requires additional pole space, and additional anchoring. For existing pole lines, BC Hydro is responsible for arranging the necessary alterations to accommodate its licensee.

c. Pole Framing and Pole Class:

The vertical separation of the third party communication messenger from the BC Hydro neutral follows the same rules that would otherwise apply to TELUS (See ES43 C1-01.02). The highest TELUS messenger, in this case, is placed on the pole 400 mm (16") below the BC Hydro third party licensee's communication messenger. To accommodate new licensees on existing joint use pole lines, where ever possible, the preference is to move existing facilities up or down if necessary. If adequate space cannot be found, then a new pole may be required. Refer to DI D12-1 for the Move Down Request for moving TELUS facilities on existing poles. Vertical wire separations at the pole are given in ES43 C2-04. Contact Shared Assets if an existing third party licensee needs to be moved or relocated.

The pole class must be selected to meet the planned requirements of all parties, namely BC Hydro, TELUS and licensee(s). To accommodate new BC Hydro licensees on existing joint use pole lines, the remaining strength capacity must be assessed accordingly to determine if the pole needs to be changed out.





d. Wire Interference:

To prevent wire interference with TELUS messengers, all third party cable must be messenger supported.

e. Anchoring and Guying:

BC Hydro is responsible for providing the required anchoring and guying for the licensee and ensuring that no anchoring capacity allocated to TELUS is compromised. The anchoring requirements of new licensees on existing joint use pole lines shall be handled as follows:

REVISIONS: R5. UPDATED CONTENT AND REFERENCES. APR. 20' KM

| | | | | | |
|---|---|---|---|--|---------------|
| DESIGNED  K. MIDDLETON | RECOMMENDED  H. GIESBRECHT | ACCEPTED  F. DENNERT | ENGINEER OF RECORD  K. D. MIDDLETON # 32387 BRITISH COLUMBIA ENGINEER | JOINT AND SECONDARY USE GENERAL NOTES | |
| DISTRIBUTION STANDARDS  | | ISSUED: APR 2020 REPLACES: NOV 2012 ORIGINALLY ISSUED: JUN 1986 | | PAGE 3 OF 4 | ES43 C1-01.03 |
| | | | | R | 5 |

i. BC Hydro/TELUS joint angle (side) anchor:

Where possible, assess spare capacity of BC Hydro/TELUS anchor. For light angles a licensee guy may not be required. Otherwise, rebuild as a single anchor or split into two anchors to attain the required holding strength.

ii..BC Hydro/TELUS joint dead end anchor:

Rebuild as a separate TELUS anchor and add a BC Hydro/licensee anchor.

iii. Separate BC Hydro and TELUS anchors at dead-end:

Assess, if possible, the spare capacity of the BC Hydro anchor. Attach licensee guy to the existing BC Hydro anchor or rebuild as required. **UNDER NO CIRCUMSTANCES ATTACH LICENSEE GUY TO TELUS ANCHOR.**

iv. BC Hydro shall approve all third party licensee design proposals for additions to joint use structures. All proposed anchoring or guying upgrades and additions that impact on TELUS facilities shall also be approved by TELUS. Installation will be done by BC Hydro and, if necessary, by TELUS.

f. Third Party Quadrant on Joint Use Poles:

The CSA Standard C22.3 No. 1 (Clause 4.2.4.1) requires that the risers for communications and supply (power) systems on the same pole be placed in separate quadrants. Refer to ES43 M1-10 and DI D12-5 for placement of the telecommunication and supply quadrants.

Note: The placing of communication risers and power risers on the same pole should be avoided where practicable.

g. Bonding and Grounding:





The communication licensee is responsible for providing adequate bonding, grounding, and coordinated protection of their system. As a minimum standard, the third party messenger shall be bonded to existing TELUS plant at intervals no greater than 400 metres. This will typically occur at neutral grounding locations. The coax sheath shall be bonded to its messenger at all passive devices. Coax service drops should be grounded as close as practical to the point of delivery.

h. Communication:

i. At the design stage for joint use pole lines, a local dialogue between BC Hydro and TELUS is essential to establish a mutually satisfactory design to accommodate the third party.



ii. BC Hydro and TELUS must convey to their respective construction crews adequate framing, anchoring and guying information pertaining to BC Hydro, TELUS and the third party to prevent construction errors.

iii. BC Hydro must convey to the third party explicit instructions on where to place wires and equipment on pole structures.

| | | | | | |
|--|---|---|---|--|----------------------|
| DESIGNED  K. MIDDLETON | RECOMMENDED  H. GIESBRECHT | ACCEPTED  F. DENNERT | ENGINEER OF RECORD  K. D. MIDDLETON # 32387 BRITISH COLUMBIA ENGINEER | JOINT AND SECONDARY USE GENERAL NOTES | |
| DISTRIBUTION STANDARDS  | | ISSUED: APR 2020 REPLACES: NOV 2012 ORIGINALLY ISSUED: JUN 1986 | | PAGE 4 OF 4 | ES43 C1-01.04 |
| | | | | R | 5 |

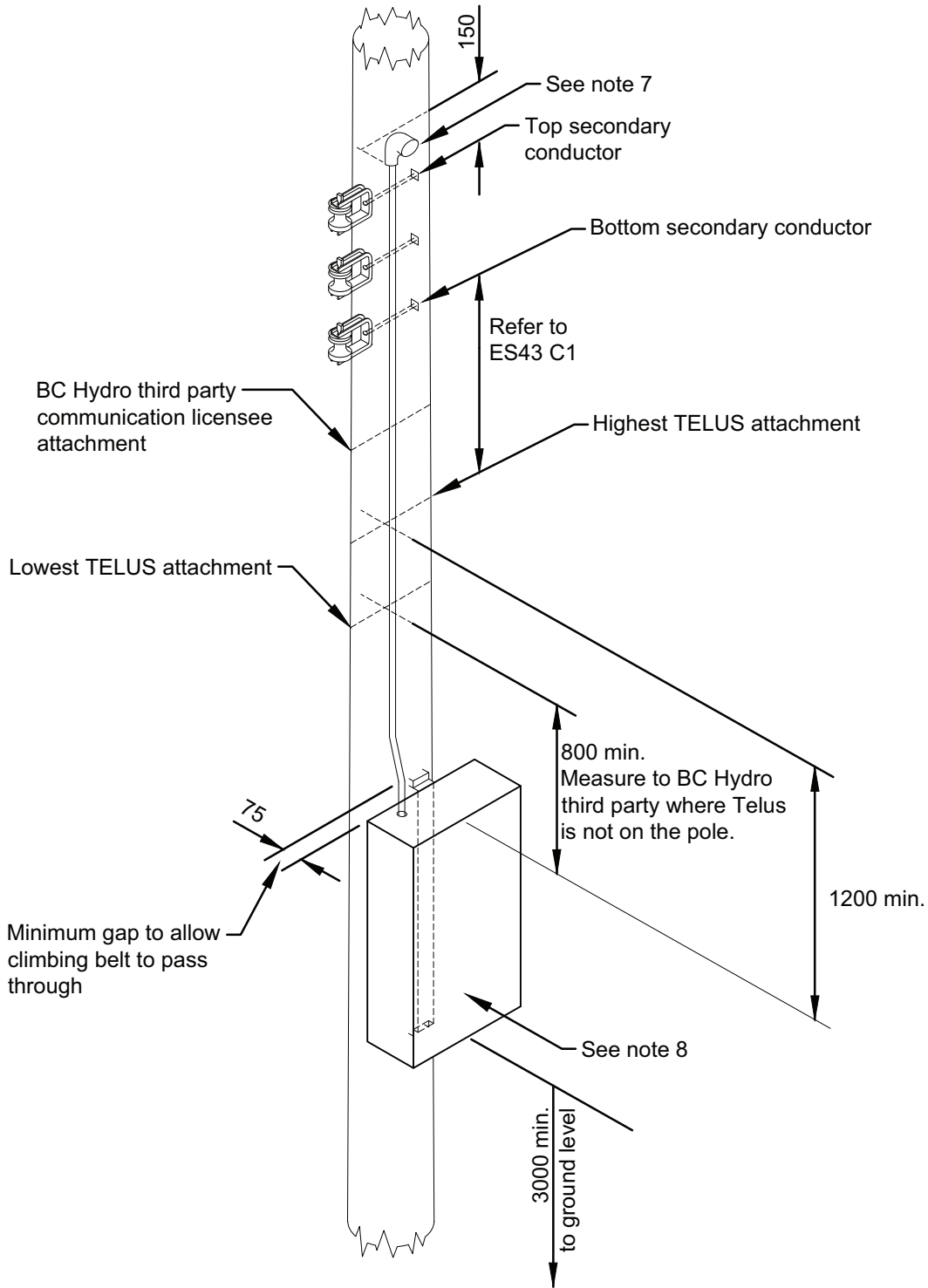
REVISIONS: R.0. -MOVED G-1-11 TO C-1-02. ADDED MIN. 1200 MM SEPERATION FROM TOP TELUS TO EQUIPMENT BOX. CLARIFIED REVIEW OF BOXES SUPPORTING TELUS LICENSEES. -APR '20 HG.



| | | | | | |
|---|--|---|--|---|--------|
| DESIGNED <i>H. Giesbrecht</i> H. GIESBRECHT | RECOMMENDED <i>K. Middleton</i> K. MIDDLETON | ACCEPTED <i>F. Dennert</i> F. DENNERT | ENGINEER OF RECORD  H. J. GIESBRECHT # 39120 BRITISH COLUMBIA ENGINEER 2020-04-22 | JOINT AND SECONDARY USE EQUIPMENT BOXES ON POLES | |
| DISTRIBUTION STANDARDS  | | | ISSUED: APR 2020 REPLACES: N/A ORIGINALLY ISSUED: APR 2020 | | |
| | | | | | R 0 |

REVISIONS: R.0. -MOVED G1-11 TO C1-02. ADDED MIN. 1200 MM SEPERATION FROM TOP TELUS TO EQUIPMENT BOX. CLARIFIED REVIEW OF BOXES SUPPORTING TELUS LICENSEES. -APR '20 HG.

Application

This standard applies to the installation of third party equipment boxes (not owned by BC Hydro or TELUS) mounted below the lowest telecommunications wire. This standard does not apply to RF emitting devices.

Notes

General





1. The location and installation of third party equipment licensed to BC Hydro is subject to review and acceptance by BC Hydro. Review and acceptance of third party equipment licensed to TELUS is to be reviewed and accepted by TELUS in conformance with this standard.

Mounting

2. Communication equipment boxes shall normally be mounted on the face of the pole or on the opposite side (i.e., not on the road or field side of the pole), and on the side opposite strand mounted communication equipment. Refer to ES43 D2-04 for an illustration of the pole face.
3. On Joint Use poles, the equipment box is to be positioned to allow adequate climbing and working space as per ES43 C1-05 and G1-04.
4. Equipment boxes shall be stood off from the pole by 75 mm to allow for climbing and belting past the box. Where the box is not stood off from the pole, the design shall be approved by local agreement between BC Hydro and TELUS.

Installation on Complex Poles

5. Equipment boxes shall not be installed on the following:
 - III. Poles with cabinets already installed by any other company.
 - IV. Poles with capacitor controls, regulator controls, recloser controls, air switch operating handles, or primary revenue metering.
 - V. Transformer poles which are not accessible to bucket truck.
 - VI. Poles with underground electric or communication riser conduits.
6. Equipment boxes should not be installed on the following wherever practicable:
 - I. Junction poles (a pole where lines run in four or more directions).
 - II. Tap poles.
 - III. Corner poles.

| | | | | | |
|--|--|---|---|---|---------------|
| DESIGNED  H. GIESBRECHT | RECOMMENDED  K. MIDDLETON | ACCEPTED  F. DENNERT | ENGINEER OF RECORD  H. J. GIESBRECHT # 39120 BRITISH COLUMBIA ENGINEER <small>2020-04-22</small> | JOINT AND SECONDARY USE EQUIPMENT BOXES ON POLES | |
| DISTRIBUTION STANDARDS  | | ISSUED: APR 2020 REPLACES: N/A ORIGINALLY ISSUED: APR 2020 | | PAGE 2 OF 4 | ES43 C1-02.02 |
| | | | | R | 0 |

REVISIONS: R.0. -MOVED G-1-11 TO C-1-02. ADDED MIN. 1200 MM SEPERATION FROM TOP TELUS TO EQUIPMENT BOX. CLARIFIED REVIEW OF BOXES SUPPORTING TELUS LICENSEES. -APR '20 HG.

Supply

- 7. Where electrical supply is provided to the box, the conduit must extend 150 mm above the top secondary clevis with suitable entrance fitting and conduit, per the BC Electrical Code for wet locations.
- 8. Foreign equipment may include a disconnecting device operable by the owner for maintenance of other equipment.

Bonding and Grounding

- 9. Bonding and grounding practices shall be per BC Hydro Standard ES43 Section R. Specifically:
 - a. Install ground electrode if not already installed at pole. Ground electrodes installed by TELUS and BC Hydro third party communication licensees at Joint Use poles shall be installed in accordance with ES43 R2-01, leaving a coil of ground wire banded to the pole below the system neutral for subsequent connection to the system neutral by BC Hydro. At every pole ground electrode location, all non-current carrying metallic communication components must be bonded to the ground wire using minimum #6 AWG insulated wire. Ground electrodes installed by TELUS may use 3/4" diameter, 10' long, galvanized steel rods as an acceptable alternative to BC Hydro ground rods (Cat. ID 420-1093).
 - b. All grounding conductors shall be theft deterrent grounding wire as shown in ES43 R2-01.

Size and Mass





- 10. Equipment boxes shall have a maximum height of 1000 mm, maximum width of 700 mm, and a maximum depth of 400 mm.
- 11. Equipment boxes shall have a maximum mass of 300 kg.

Identification

- 12. The equipment box shall be clearly marked with the owner's equipment ID#, the company name, and the emergency contact phone number.

Ground Clearance

- 13. Equipment boxes shall be installed with a minimum 3.0 m clearance from the bottom of the box to ground level.
- 14. Special mounting height provisions for FortisBC rectifier or telemetry boxes:
 - a. The minimum mounting height to the bottom of the box shall be 2.0 m from finished grade where safe ladder access is possible.
 - b. When ladder access is not possible, the minimum mounting height can be reduced to 1.5 m,

| | | | | | |
|--|--|---|--|---|---------------|
| DESIGNED  H. GIESBRECHT | RECOMMENDED  K. MIDDLETON | ACCEPTED  F. DENNERT | ENGINEER OF RECORD  H. J. GIESBRECHT # 39120 BRITISH COLUMBIA ENGINEER 2020-04-22 | JOINT AND SECONDARY USE EQUIPMENT BOXES ON POLES | |
| DISTRIBUTION STANDARDS  | | ISSUED: APR 2020 REPLACES: N/A ORIGINALLY ISSUED: APR 2020 | | PAGE 3 OF 4 | ES43 C1-02.03 |
| | | | | R 0 | |

REVISIONS: R.0. -MOVED G1-11 TO C1-02. ADDED MIN. 1200 MM SEPERATION FROM TOP TELUS TO EQUIPMENT BOX. CLARIFIED REVIEW OF BOXES SUPPORTING TELUS LICENSEES. -APR '20 HG.

provided the following stipulations are met:

- I. The pole location is at least 2.0 m away from any area used by motorized vehicles (e.g., road/driveway/ATV trail).
- II. The installation location has a low or medium probability of public interaction*. For installations where the requirement for low or medium risk is not practicable and foot traffic is expected, the installation is acceptable provided the following conditions are met:
 - i. No sidewalk, bicycling trail, or other indication of frequent foot traffic within 2.0 m of the pole location.
 - ii. No reason for public congregation (e.g., schools, parks, bus stops, shopping centres) within a distance of 50 m.
 - iii. No foreseeable likelihood that any of the above would become true in the near future.
- c. If the stipulations for mounting at 2.0 m or 1.5 m cannot be met, an alternative location shall be selected.

***Definitions of Public Interaction**





High: Within boundary of city, town, or village; near sidewalk or public pathways; near schools, parks, highway pullouts, etc.

Medium: Within unincorporated communities (e.g., townships, counties), and along roadways where light foot traffic is expected.

Low: Along roadways with little to no foot traffic.

Reference Standards

| | |
|------------|--|
| ES43 C1-05 | Climbing and Working Space |
| ES43 D2-04 | Standard Framing for Wood Distribution Poles |
| ES43 G1-04 | Climbing Space through Drop Wires, Communication and Secondary |
| ES43 R2-01 | Ground Rods at Wood Poles and Multiple Ground Rods |
| ES43 R7-01 | Bonding and Grounding Other Utilities Grounding Connections |

| | | | | | |
|--|--|---|---|--|-----------------------------|
| DESIGNED  H. GIESBRECHT | RECOMMENDED  K. MIDDLETON | ACCEPTED  F. DENNERT | ENGINEER OF RECORD  H. J. GIESBRECHT # 39120 BRITISH COLUMBIA ENGINEER <small>2020-04-22</small> | <p>JOINT AND SECONDARY USE EQUIPMENT BOXES ON POLES</p> | |
| <p>DISTRIBUTION STANDARDS </p> | | <p>ISSUED: APR 2020 REPLACES: N/A ORIGINALLY ISSUED: APR 2020</p> | | <p>PAGE 4 OF 4</p> | <p>ES43 C1-02.04</p> |
| | | | | <p>R</p> | <p>0</p> |

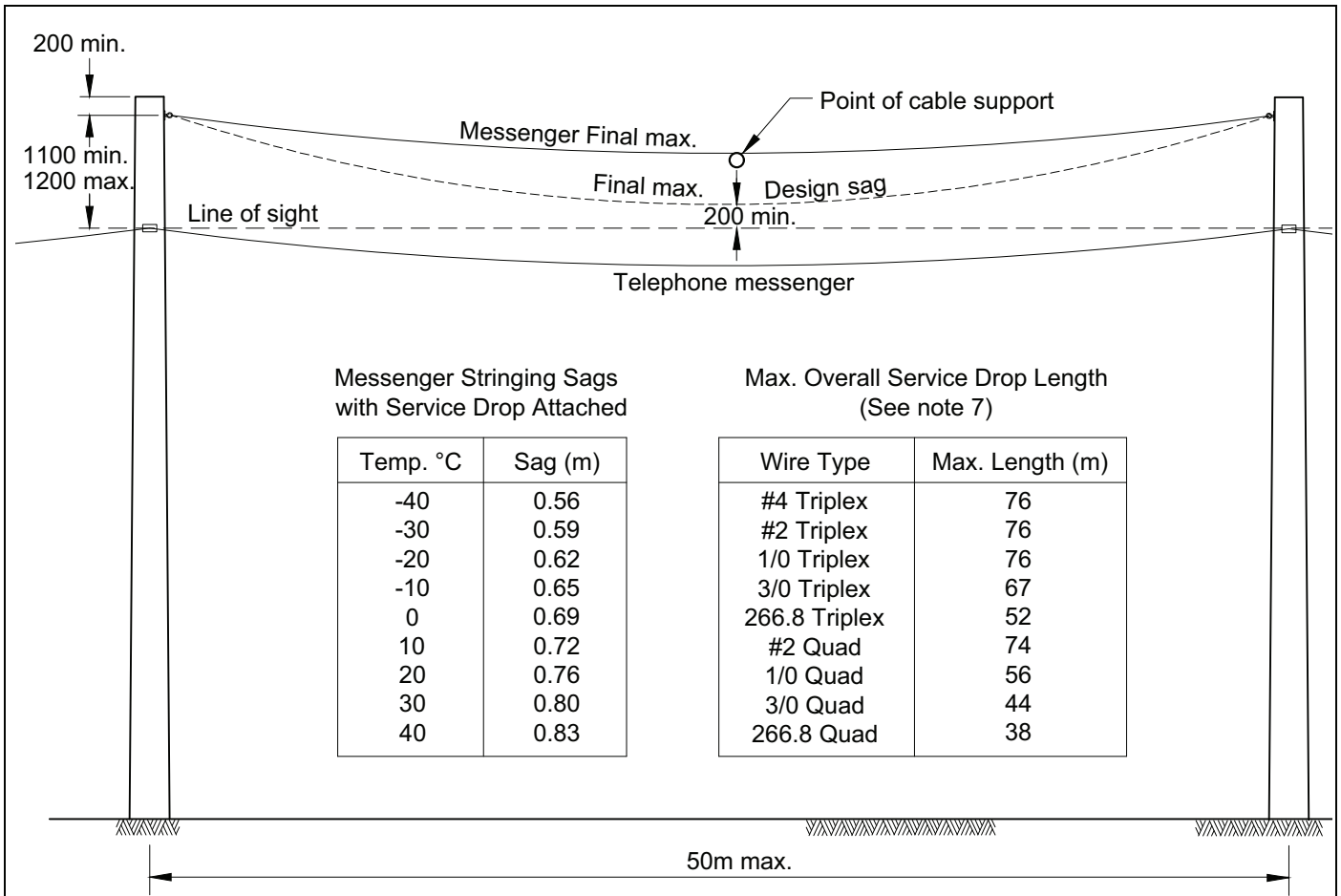

Messenger Stringing Sags with Service Drop Attached

| Temp. °C | Sag (m) |
|----------|---------|
| -40 | 0.56 |
| -30 | 0.59 |
| -20 | 0.62 |
| -10 | 0.65 |
| 0 | 0.69 |
| 10 | 0.72 |
| 20 | 0.76 |
| 30 | 0.80 |
| 40 | 0.83 |

Max. Overall Service Drop Length (See note 7)

| Wire Type | Max. Length (m) |
|---------------|-----------------|
| #4 Triplex | 76 |
| #2 Triplex | 76 |
| 1/0 Triplex | 76 |
| 3/0 Triplex | 67 |
| 266.8 Triplex | 52 |
| #2 Quad | 74 |
| 1/0 Quad | 56 |
| 3/0 Quad | 44 |
| 266.8 Quad | 38 |

Figure 1
Service Drop Support Messenger Configuration On Telephone Pole Line

Notes

1. This standard applies to a stand-alone single span of messenger to support a single service drop. Multiple spans in series require an engineered site-specific design.
2. This standard to be used only where avoidance alternatives are not viable.
3. Replace existing poles if necessary to provide the required messenger clearance. Pole top extensions are not acceptable for the purpose.
4. This standard may only be used on spans where a tensioned telephone messenger is present.
5. Sag messenger to correct stringing sag with service drop attached.
6. The B.C. Electrical Code requires that the bare neutral conductor be insulated from the support messenger.
7. Maximum permitted service drop length from messenger support point to attachment points on either side is 38 m.

REVISIONS: R3, NEW FORMAT, APR. 20' KM

| | | | | | | |
|-----------------------------------|----------------------------------|---|--|---|----------------------|---------------|
| DESIGNED K. MIDDLETON | RECOMMENDED H. GIESBRECHT | ACCEPTED F. DENNERT | ENGINEER OF RECORD K. D. MIDDLETON # 32387 BRITISH COLUMBIA ENGINEER | JOINT AND SECONDARY USE MESSENGER SUPPORTED CLEARANCE CONTACT FOR MULTIPLEX CABLE SERVICE DROP | | |
| DISTRIBUTION STANDARDS | | ISSUED: APR 2020 REPLACES: AUG 2011 ORIGINALLY ISSUED: MAY 2000 | | PAGE 1 OF 2 | ES43 C1-04.01 | R 3 |

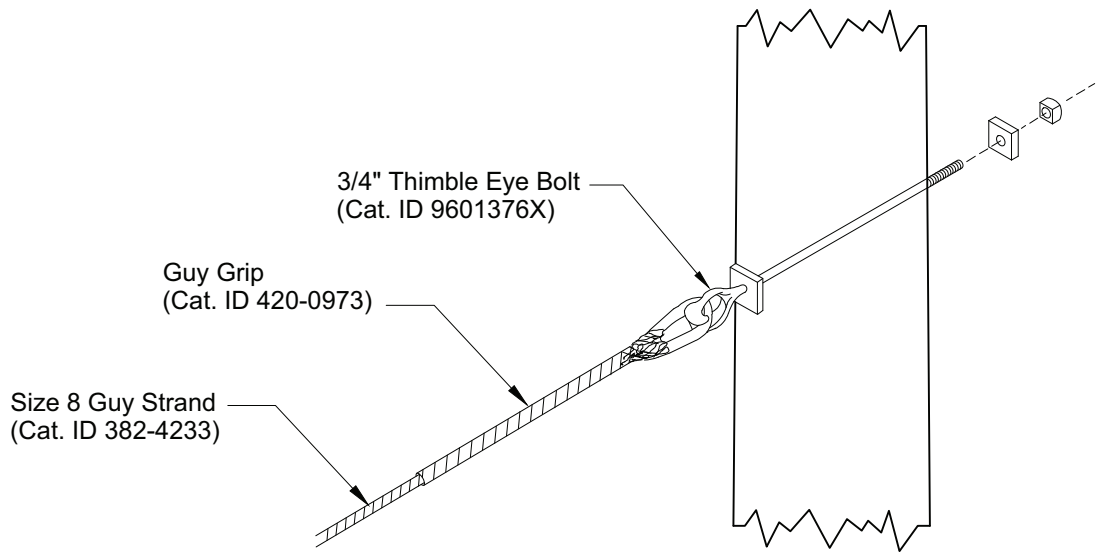

Figure 2
Span Guy Attachment

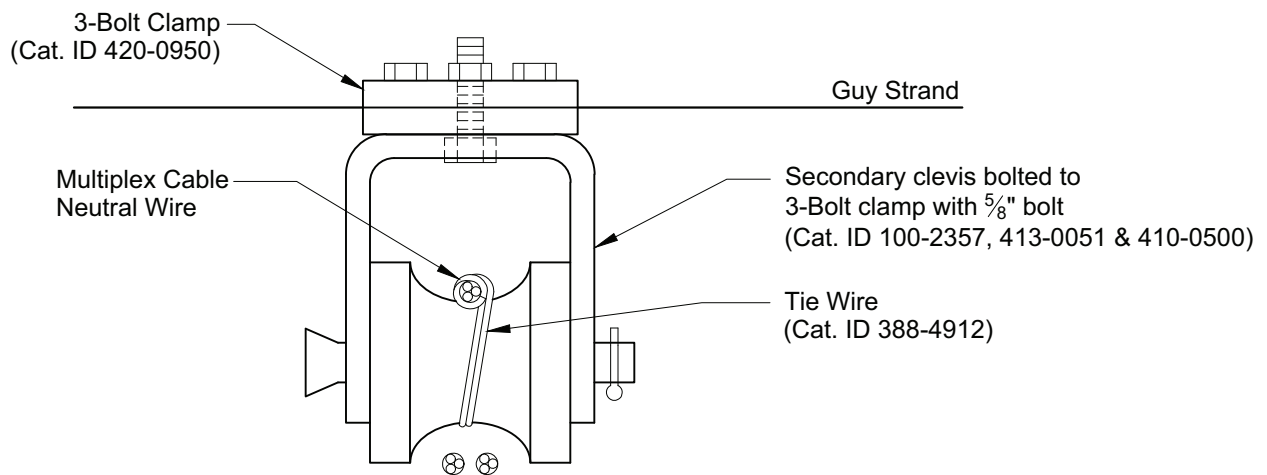

Figure 3
Cable Attachment to Messenger

Reference Standards

ES43 N1-02 Secondary Ties

REVISIONS: R3, NEW FORMAT, APR. 20' KM

| | | | | | | |
|---|--|---|--|---|--|----------------|
| DESIGNED <i>K. Middleton</i> K. MIDDLETON | RECOMMENDED <i>H. Giesbrecht</i> H. GIESBRECHT | ACCEPTED <i>F. Dennert</i> F. DENNERT | ENGINEER OF RECORD K. D. MIDDLETON # 32387 BRITISH COLUMBIA ENGINEER | JOINT AND SECONDARY USE MESSENGER SUPPORTED CLEARANCE CONTACT FOR MULTIPLEX CABLE SERVICE DROP | | |
| DISTRIBUTION STANDARDS | | ISSUED: APR 2020 REPLACES: AUG 2011 ORIGINALLY ISSUED: MAY 2000 | | | | PAGE 2 OF 2 |

Application

This standard applies to the assessment of climbing and working space for attachment of equipment to Joint Use poles.

Design Notes

Joint Use poles shall be kept free of unauthorized attachments that could be hazardous and obstruct or otherwise hamper the operations of the utilities using the structures.

Climbing Space

1. Equipment shall be stood off from the pole by 75 mm to allow for climbing and belting past.

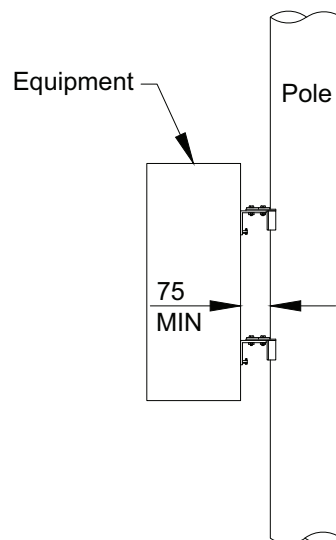



Figure 1: Required separation between pole and equipment

2. Climbing space should be free from obstructions and shall provide sufficient space, adjacent to the pole to allow safe access to wires, equipment, and other attachments above the telecommunications space.
3. The climbing space should be not less than 750 mm x 750 mm adjacent to any conductors, cables, crossarms, or other attachments and shall extend at least 1 m above and 1 m below the limiting attachments.
4. Poles not accessible by bucket truck shall have contiguous climbing space starting at the ground level and ending above the equipment mounting level to allow for installation of equipment and rescue of workers.

| | | | | | | |
|------------|--|--|---|--|---|----------------------|
| REVISIONS: | DESIGNED <i>H. Giesbrecht</i> H. GIESBRECHT | RECOMMENDED <i>K. Middleton</i> K. MIDDLETON | ACCEPTED <i>F. Dennert</i> F. DENNERT | ENGINEER OF RECORD  H. J. GIESBRECHT # 39120 2020-04-30 | JOINT AND SECONDARY USE CLIMBING AND WORKING SPACE | |
| | DISTRIBUTION STANDARDS  | ISSUED: APR 2020 REPLACES: N/A ORIGINALLY ISSUED: N/A | | | PAGE 1 OF 5 | ES43 C1-05.01 |

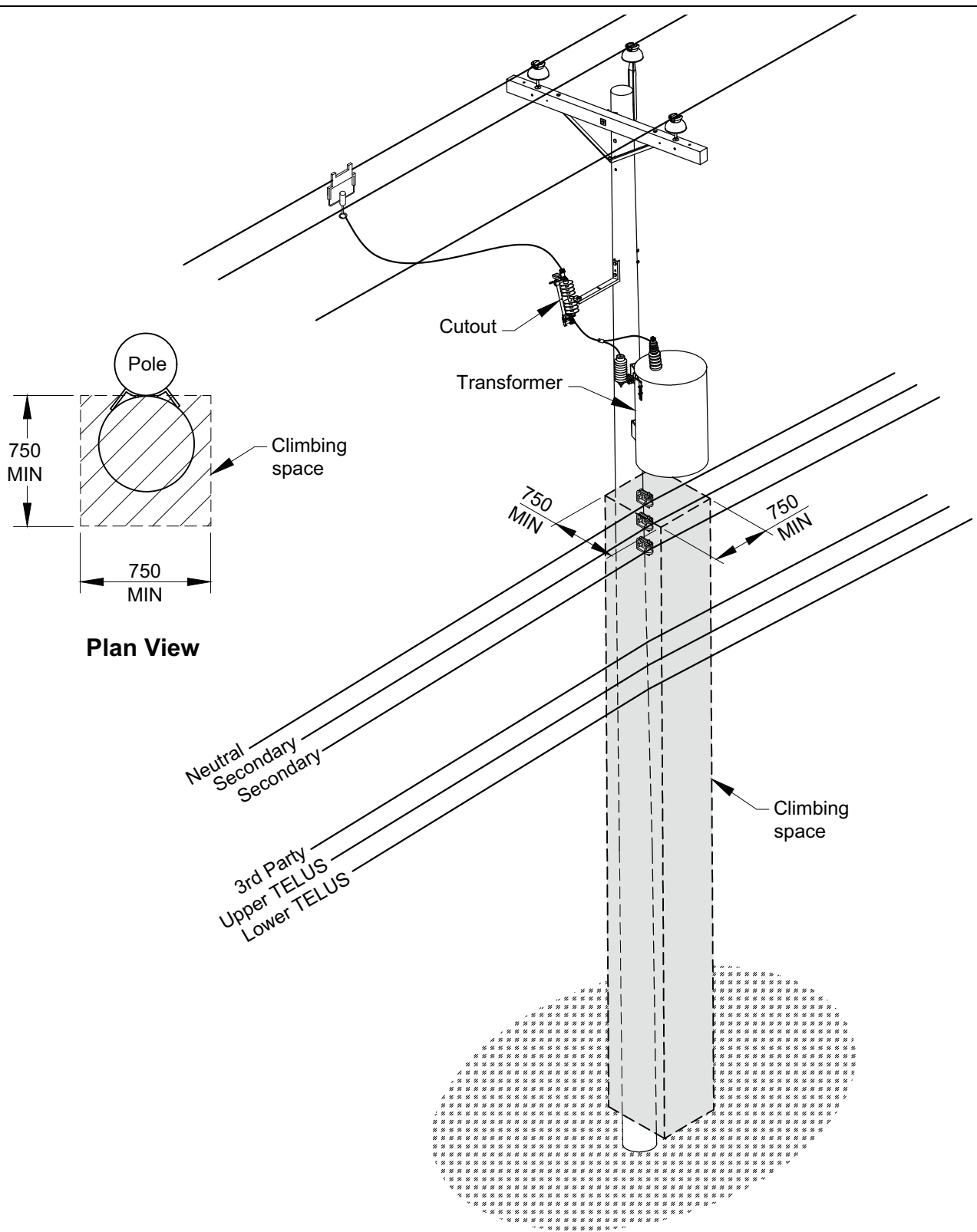

Figure 2: Climbing space for equipment poles not accessible by bucket truck

| | | | | | | |
|-----------------------------------|----------------------|---|-------------------|--------------------|---|---------------|
| REVISIONS: | DESIGNED | RECOMMENDED | ACCEPTED | ENGINEER OF RECORD | JOINT AND SECONDARY USE CLIMBING AND WORKING SPACE | |
| | <i>H. Giesbrecht</i> | <i>K. Middleton</i> | <i>F. Dennert</i> | | | |
| | H. GIESBRECHT | K. MIDDLETON | F. DENNERT | 2020-04-30 | PAGE 2 OF 5 | ES43 C1-05.02 |
| DISTRIBUTION STANDARDS | | ISSUED: APR 2020 REPLACES: N/A ORIGINALLY ISSUED: N/A | | | | |

Working Space

5. Working space shall be provided on the climbing face of the structure and shall have minimum horizontal dimensions of 750 mm x 750 mm. The height of the working space shall extend above the top communication position by 1000 mm and below the lowest communication position by 1300 mm.
6. Note: In cases where workers are expected to make use of ladders for climbing the structure, the working space will be near the top of the climbing space.

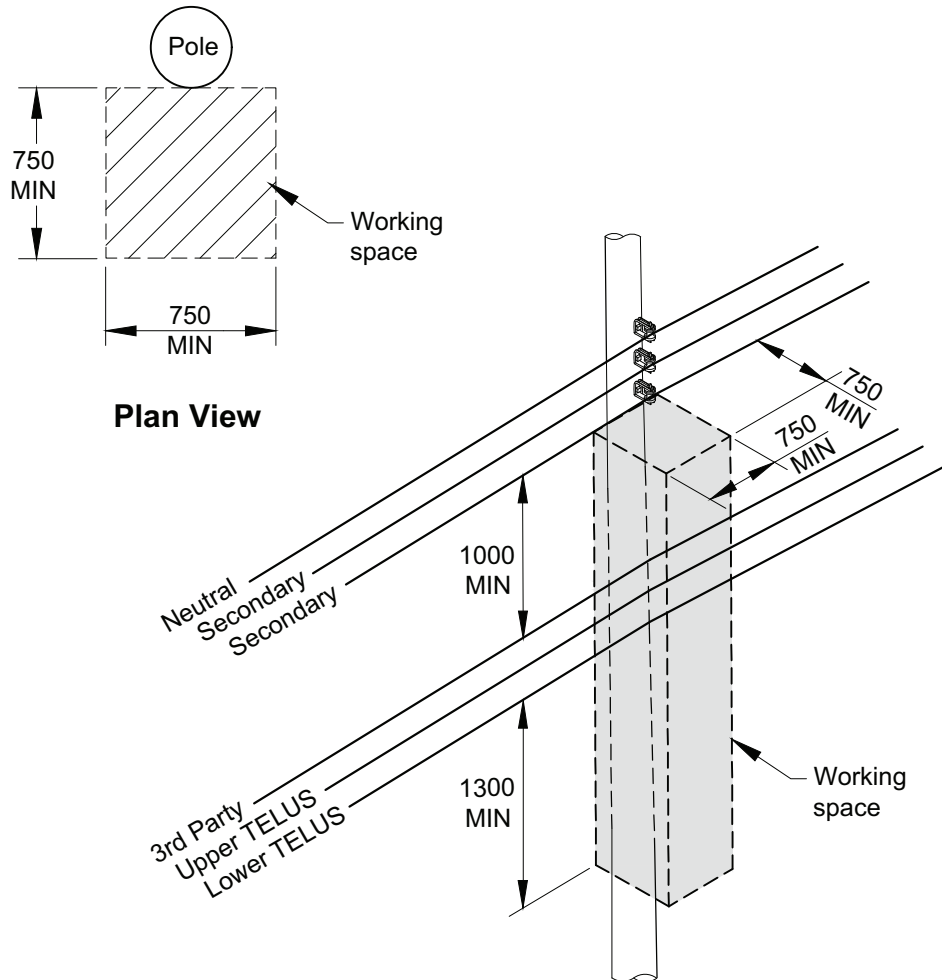



Figure 3: Working Space for Telecommunication Wire Attachments

| | | | | | |
|--|--|---|--|---|---------------|
| DESIGNED <i>H. Giesbrecht</i> H. GIESBRECHT | RECOMMENDED <i>K. Middleton</i> K. MIDDLETON | ACCEPTED <i>F. Dennert</i> F. DENNERT | ENGINEER OF RECORD  H. J. GIESBRECHT # 39120 BRITISH COLUMBIA ENGINEER 2020-04-30 | JOINT AND SECONDARY USE CLIMBING AND WORKING SPACE | |
| REVISIONS: DISTRIBUTION STANDARDS  | ISSUED: APR 2020 REPLACES: N/A ORIGINALLY ISSUED: N/A | | | PAGE 3 OF 5 | ES43 C1-05.03 |
| | | | | R | 0 |

Obstructions

- The attachment of equipment such as wireless antennas or cabinets shall not obstruct line of sight access from a safe ground position to a cutout or switch. The cut-out or switch orientation as well as the available clear ground space around the pole must be considered. If the unobstructed operation of a cut-out or switch is uncertain, the proposed attachment shall be reviewed with BC Hydro Field Operations.

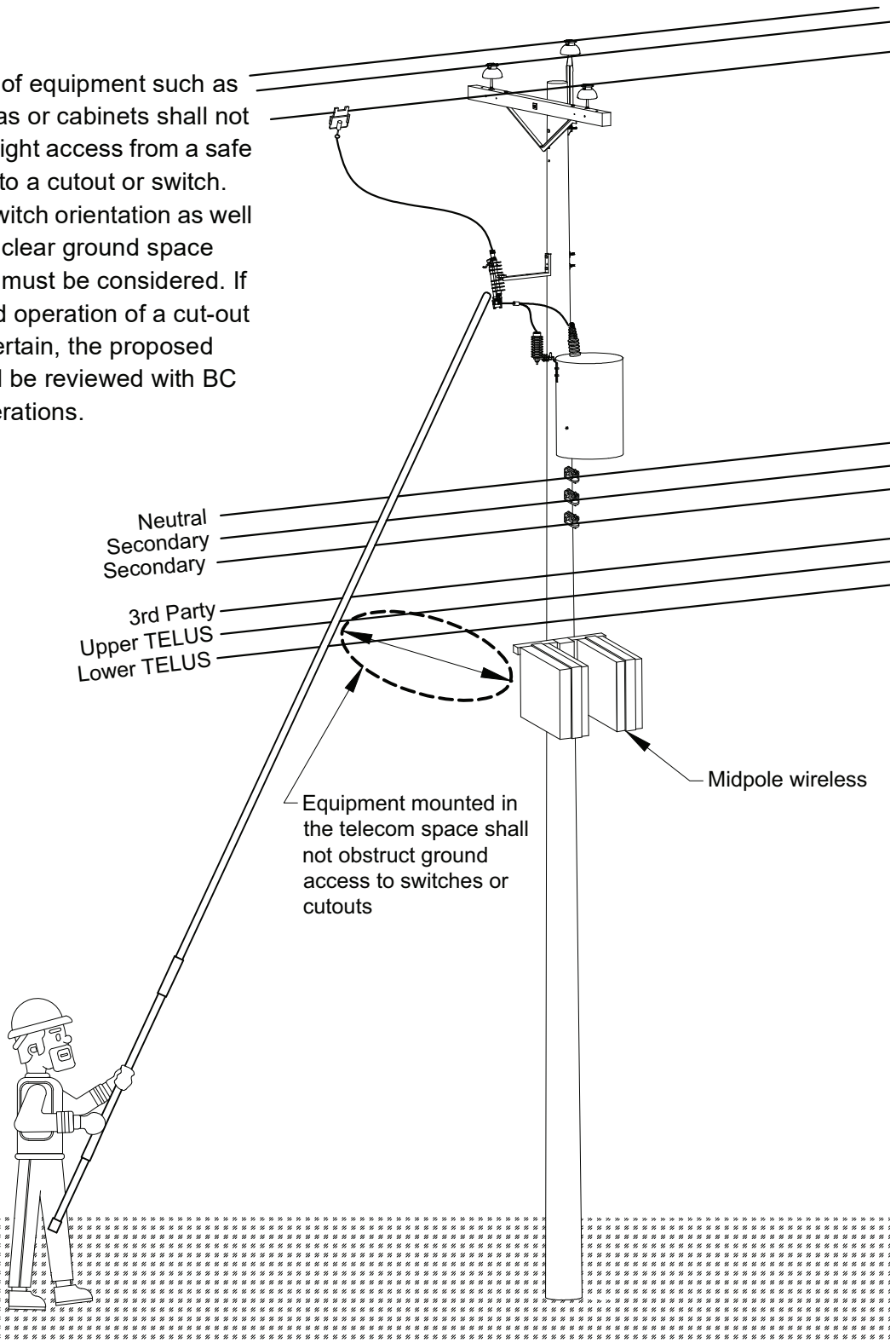

Figure 4: Unobstructed ground access to cut-outs and switches





| | | | | | | |
|------------|------------------------|---------------------|------------------------|--------------------|---|---------------|
| REVISIONS: | DESIGNED | RECOMMENDED | ACCEPTED | ENGINEER OF RECORD | JOINT AND SECONDARY USE CLIMBING AND WORKING SPACE | |
| | <i>H. Giesbrecht</i> | <i>K. Middleton</i> | <i>F. Dennert</i> | | | |
| | H. GIESBRECHT | K. MIDDLETON | F. DENNERT | | PAGE 4 OF 5 | ES43 C1-05.04 |
| | DISTRIBUTION STANDARDS | | ISSUED: APR 2020 | | | |
| | BC Hydro | | REPLACES: N/A | | | |
| | | | ORIGINALLY ISSUED: N/A | | | |

8. Attachments on the structure shall not encroach on the climbing space or working space, with the exception of
 - a) pole steps at the side of the climbing space or working space on non-wooden poles
 - b) crossarms along the side of the working space or climbing space
 - c) tangent communication wire along the side of the working space or climbing space, provided that their vertical arrangement does not obstruct climbing of the structure;
 - d) tangent open wire secondary or neutral supported secondary (duplex, triplex, quadruplex)
 - e) cable covers for communication or power dips.
 - f) other equipment or items that both BC Hydro and TELUS agree do not interfere with the use of climbing equipment.

9. Radiofrequency emitting devices such as radio, cellular, and WIFI antennas shall be equipped with a shut off to allow climbing and working on the pole within the minimum safe working distance of the antenna. Refer to the Work Methods documents RF Safety – BC Hydro Owned Equipment and RF Safety – Third Party Equipment.

Reference Standards

- ES43 G1-04 Climbing Space Through Drop Wires Communication & Secondary
 ES43 M1-01 Terminal Poles General Notes

| | | | | | | |
|------------|--|---|---|---|---|--|
| REVISIONS: | DESIGNED | RECOMMENDED | ACCEPTED | ENGINEER OF RECORD | JOINT AND SECONDARY USE CLIMBING AND WORKING SPACE | |
| |  H. GIESBRECHT |  K. MIDDLETON |  F. DENNERT |  | | |
| | DISTRIBUTION STANDARDS  | ISSUED: APR 2020 REPLACES: N/A ORIGINALLY ISSUED: N/A | | | R 0 | |